

## Lithium Nickel Manganese (LiNiMnCo) Battery Specification

### SLAUMXLI7-12-NCM (11.1V18AH)

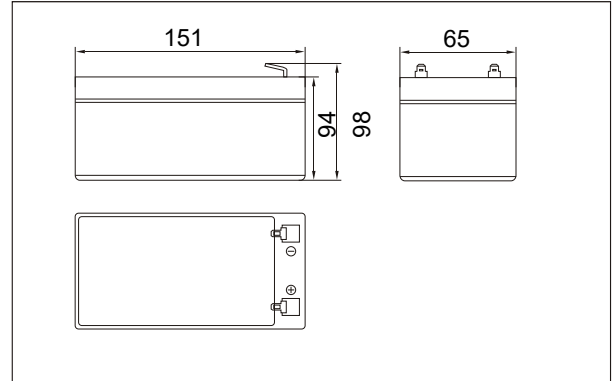

#### Outer dimensions (mm)



#### Specifications

Nominal Voltage		11.1V
Rated capacity (20 hour rate)		7Ah
Dimensions	Total Height	98mm
	Height	94 mm
	Length	151 mm
	Width	65mm
Weight Approx		0.6 Kg
Terminal		T2

#### Terminal Type (mm)

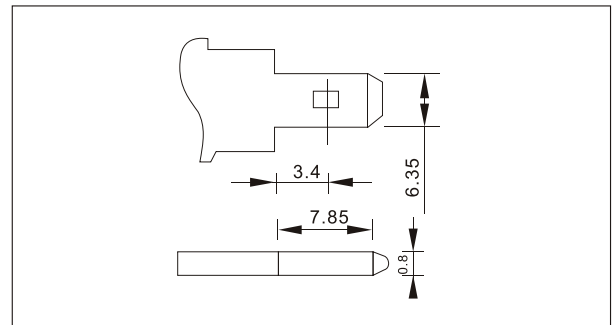

#### Characteristics

Capacity Retention		>80% at 28 days
Cycle Life		>80% at 2000 Cycles
1.5 hour discharge to 10.5V		3.00 A
Internal Resistance		<50 mΩ
Charge Characteristics	Charge Voltage	12.6±0.1V
	Charger Current	<7A
Discharge Characteristics	Max Continuous Current	10A
	Min Discharge Cut-off Voltage	8.25V
Temperature	Charge Temperature	0°C-45°C(32°F-113°F)
	Discharge Temperature	-20°C-60°C(-4°F-140°F)
	Storage Temperature	0°C-40°C(32°F-104°F)

#### Discharge Curves 25°C(77 °F)

