

Lithium Nickel Manganese (LiNiMnCo) Battery Specification

SLAUMXLI18-12-NCM (11.1V18AH)

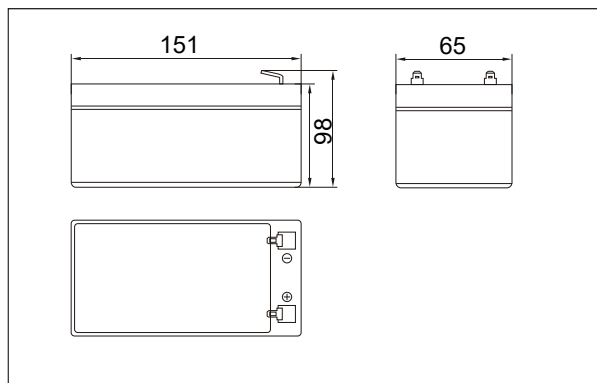

Outer dimensions (mm)



Specifications

Nominal Voltage	11.1V	
Rated capacity (20 hour rate)	18Ah	
Dimensions	Total Height	98mm
	Height	94 mm
	Length	151 mm
	Width	65mm
Weight Approx	1.1 Kg	
Terminal	T2	

Terminal Type (mm)

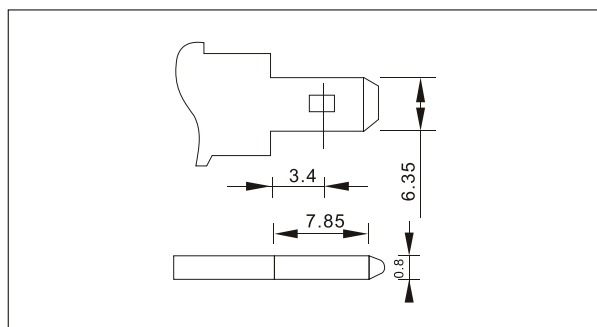

Characteristics

Capacity Retention	>80% at 28 days	
Cycle Life	>80% at 2000 Cycles	
1.5 hour discharge to 10.5V	3.00 A	
Internal Resistance	<30 mΩ	
Charge Characteristics	Charge Voltage	12.6±0.1V
	Charger Current	<10A
Discharge Characteristics	Max Continuous Current	15A
	Min Discharge Cut-off Voltage	8.25V
Temperature	Charge Temperature	0°C-45°C(32°F-113°F)
	Discharge Temperature	-20°C-60°C(-4°F-140°F)
	Storage Temperature	0°C-40°C(32°F-104°F)

Discharge Curves 25°C(77 °F)

